



INTELLISPEC™

Hardware Guide

Series 6 Vision Pro- cessor

SOFTWARE VERSION: 6.0 AND UP

MANUAL PART NUMBER: 81748 REV. 01

MODULE MODEL NUMBER(S): 81134 AND 81135

Copyright Notice / Contact Us

© 2021 Pressco Technology Inc. All rights reserved.

No part of this manual may be reproduced or transmitted in any form or by any means, electronic or mechanical, including photocopying and recording, for any purpose, without the express written permission of Pressco Technology Inc.

The contents of this manual are furnished for informational use only, are subject to change without notice, and should not be construed as a commitment by Pressco Technology Inc.

Written and designed at:

Pressco Technology Inc. World Headquarters

29200 Aurora Road

Cleveland, OH USA 44139-1847

TEL +1-440-498-2600

FAX +1-440-498-2615

www.pressco.com

Business Hours: Monday - Friday, 8:00am - 5:00pm Eastern Time

Customer Support:

Request technical support and remote support: techsupport@pressco.com

24/ 7 Customer Support (for urgent system help): +1-440-498-2000

e-mail: Schedule a service visit: dispatch@pressco.com

Request technical support and remote support: techsupport@pressco.com

Customer Service Fax: +1-440-498-4761

Table of Contents

Chapter 1 Pressco Introduction	6
About This Manual	6
Safety Considerations	7
Static Discharge Protection	7
Chapter 2 Safety Information	8
Health Warning - Photosensitive Epilepsy	8
Symbols Used With This System	9
Label Description - Intellispec	10
Warning Devices	10
Light Tree	11
Residual Risk	11
Intended Use	11
Prohibited Use	11
Personal Protective Equipment	12
Personnel Safety	12
Lifting Heavy Objects	13
Authorized Users	14
Spare Parts Usage	14
Chapter 3 System Specifications	16
Environmental Conditions	16
Sound Pressure Level	16
Specifications - Intellispec Series 6	17
Chapter 4 Installation	19
Shipping and Handling	19
Recommendations Prior to Installation	19
Utilities to be Supplied by Customer	20
Protective Earthing	20

Electrical Connection	21
Reject Valve Pneumatic Diagram	21
Installation	21
Ventilation	22
Stability of User Interface	22
Commissioning	22
Chapter 5 Intellispec Control Enclosure and User Interface S6	23
USB Ports S6	24
Biometric Login Device	24
Power On and Off at the Control Enclosure	25
Accessing the Internal Components with the Power Off S6	25
Lockout Procedure	25
Accessing the Internal Components with the Power On	26
Rebooting the Intellispec System	27
Chapter 6 Components and Interconnect Diagrams	29
External Connections	29
Light Tree S6	29
Internal Components	31
Chapter 7 Wiring Diagrams S6	34
Wiring Diagram F1959W Sheet 1 of 6	34
Wiring Diagram F1959W Sheet 2 of 6	35
Wiring Diagram F1959W Sheet 3 of 6	36
Wiring Diagram F1959W Sheet 4 of 6	37
Wiring Diagram F1959W Sheet 5 of 6	38
Wiring Diagram F1959W Sheet 6 of 6	39
Chapter 8 Extended I-O S6	40
Extended I-O Board S6	40
Extended I-O Signals S6	41

Extended I-O Switch SW1 Selection	48
Extended I-O Circuits S6	49
Extended I-O Configuration	50
Chapter 9 Maintenance	54
Maintenance Frequency	54
Clean the Control Cabinet Filters	55

Chapter 1 Pressco Introduction

Welcome!

Congratulations on your purchase of an Intellispec system! The Intellispec is a high-speed machine vision system designed specifically for product and online process monitoring. It is a powerful tool that provides inspection much more reliably than the human eye or sampling methods. The latest PC technology, powerful inspection algorithms, online adjustment capability, and inspection data storage allow the Intellispec to automatically inspect parts with extreme accuracy on high-speed lines.

The Intellispec will help you provide the highest quality of products shipped to your customers.

About This Manual



IMPORTANT: *Keep this manual for future reference*

This book is considered an integral part of the system and should be kept handy for future reference as long as the system is being used in your plant.

The purpose of this manual is to describe the Intellispec Vision Processor and associated hardware. It is intended for trained users.

This manual:

- Is your responsibility to keep in good condition, in a dry place, and ready for consultation by the authorized users of the system.
- Contains the technology implemented at the time of selling and supplying the system and shall not be considered inadequate in case of technological enhancements in the machine or in the manual's illustrations.

Related books include:

- Intellispec Operator's Guide which has Operator-level user instructions, and is a good place to start if you are new to Intellispec
- Intellispec Software Guide which has Administrator-level user instructions

The following types of alerts may appear in this guide:



DANGER! - Danger messages alert you to specific conditions that can cause serious or fatal personal injury. Danger messages give you important information which must be observed to prevent injury.



WARNING: - Warning messages indicate information which must be observed to prevent injury, data loss, or equipment damage.



CAUTION - Caution messages indicate important information which must be observed to prevent: loss of data, poor system performance, or equipment damage.

Note: Notes contain special information that warrants being set off from the body text as shown here.



IMPORTANT - Indicates prerequisites or information that must be observed to complete or understand a concept or task.

TIP: Provides helpful hints for completing a task.

Safety Considerations

Observe the following safety warnings when operating the system or working near it:



WARNING - Potential for projectiles to strike persons and cause injury. Keep clear of reject devices.



WARNING - Sensitive electronics and High Voltages may be exposed. Keep Processor Cabinet/ Electrical Control Box door closed.

Static Discharge Protection



Caution - Electronic components can be damaged by static electricity discharge.

Always observe the following precautions before removing, installing or handling any electronic components within the Inspection System:

- Wear an anti-static wristband which is grounded to the Inspection System.
- Stand on an anti-static, grounded floor mat, and lay circuit boards on the mat during any board replacement.
- Keep circuit boards in static shield bags when storing and transporting. Ensure the bag is sealed.

Chapter 2 Safety Information

This section contains operator safety information that must be read before operating or servicing the system.



WARNING - This product contains no operator serviceable parts. Refer servicing to qualified personnel. To prevent electrical shock do not open cabinet doors whilst power is connected.



WARNING - Do not, under any circumstances, tamper with sealed machine parts or devices. This could result in the removal of protections that might create potentially hazardous conditions.



CAUTION - Possible hazardous optical radiation from LEDs. Do not stare at lamps.

Health Warning - Photosensitive Epilepsy



WARNING: PHOTOSENSITIVE EPILEPSY/ SEIZURES

A small percentage of individuals may experience epileptic symptoms or seizures when exposed to certain patterns or flashing lights. Exposure to the flashing lights in vision inspection systems may also trigger epileptic symptoms or seizures in these individuals. These flashing lights may trigger epileptic symptoms or seizures in persons who have no history of epileptic symptoms or seizures. If you, or anyone in your family has an epileptic condition or has had seizures of any kind, consult your physician before operating this machinery.

IMMEDIATELY DISCONTINUE use and consult your physician if you experience any of the following symptoms while operating this machinery:

- Dizziness
- Altered vision
- Eye or muscle twitches
- Loss of awareness
- Disorientation
- Seizures
- Any involuntary movement or convulsion

Epileptic symptom or seizure triggers vary from person to person. Some common triggers are:











- Flashing lights used for vision inspection systems or fire alarms
- Certain video games or TV broadcasts containing rapid flashes or alternating patterns of different colors
- Bright, contrasting patterns such as white bars against a black background
- Flashing white light followed by darkness
- Stimulating images that take up your complete field of vision, such as being very close to a TV screen or computer monitor
- Certain colors, such as red and blue

If you encounter something that might trigger epileptic symptoms or seizures without warning:

- Do not close your eyes (this could cause a flicker effect)
- Do not look directly at the flashing lights or trigger source
- Do cover one eye with the palm of your hand immediately
- Do turn away from the flashing lights or trigger source

Symbols Used With This System

The following symbols are used on or near the Pressco system. Be aware of potential risk hazards.

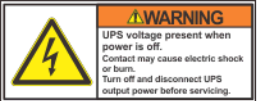
Symbol	Meaning
	CAUTION: Risk of danger. Refer to accompanying user documentation before use.
	WARNING: Risk of electric shock
	WARNING: Risk of arc flash explosion
	WARNING: Risk of electrical shock
	WARNING: Risk of burns from hot surface
	WARNING: Hand crush hazard
	On (supply)
	Off (supply)
	Alternating current
	Protective conductor terminal
	Warning: Arc flash and shock hazard
	Warning: UPS voltage present when power is off

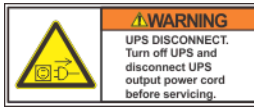

Warning: UPS Disconnect

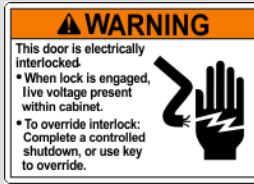

Warning: Electrical interlock



Danger: shock and arc flash explosion hazards

Label Description - Intellispec

The following illustration shows an example label that you will find on the Intellispec system components.

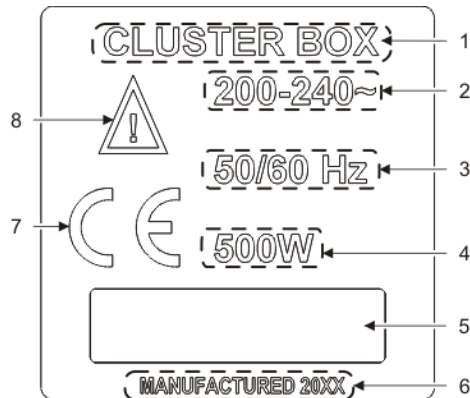

- 1) Name of component. NOTE: The Chromapulse model is listed on the front panel of the module.
- 2) Voltage range in Volts AC
- 3) Frequency range in Hertz (Hz)
- 4) Maximum rated power in watts (W) with all accessories or plug-in modules connected
- 5) Serial number is listed in this box
- 6) Year of manufacture
- 7) Component certification
- 8) Risk of danger. Refer to accompanying documentation before use.

Warning Devices

The Pressco system has warning devices that indicate system failure or report excessive defects or warnings for your production line. These include an optional light tree, alarms and indicators on screen, and audible warnings (depending on system).

Light Tree

The optional light tree is mounted on a pole in a customer-specified location.



The light tree color segments represent each alarm or system condition. A color segment may appear for more than one alarm condition.

Residual Risk

The Pressco system has been designed to minimize any danger of personal injury. However, the system uses rejection devices to remove defective product from the production stream. Also, the electronics cabinets contain risk of shock if they are opened.

Observe the following safety warnings when operating the system or working near it:



WARNING - Potential for projectiles to strike persons and cause injury. Keep clear of reject devices.



WARNING - Sensitive electronics and High Voltages may be exposed. Keep Processor Cabinet/ Electrical Control Box door closed.

Intended Use

Type of Process The Pressco system is intended to monitor container and other special manufacturing processes and identify non-conforming product.

Intended Use The Pressco system is designed and constructed for use in an indoor industrial environment, always sheltered from the weather.

Space Required The Pressco system and accompanying sensors must be installed in a place that will enable safe and easy installation, size changeover, user operation, and maintenance procedures.

Prohibited Use



WARNING - If this instrument is not used as specified, the protection provided by the equipment could be impaired. This instrument must only be used in a normal condition (in which all means of protection are intact).



Important - The Pressco system should NOT be used for any purpose other than specifically indicated in the section titled "**Intended Use**" above.

The following uses are not intended:



Use in an explosive environment



Use in a flammable environment







Use in a damp, moist, or wet environment, except where specifically indicated

Personal Protective Equipment

 *Important - Always follow the safety requirements of your plant in addition to the recommendations below.*





We recommend, at minimum, use of the following Personal Protective Equipment (PPE):

	Protective clothing
	Protective gloves
	Protective ear plugs or headphones
	Protective eye wear
	Protective foot wear

Personnel Safety

The following rules are recommended to ensure the safety of personnel in charge of machine operation and maintenance.

During machine operation:

	Only one operator is needed to operate the machine. All others must keep at a safe distance.
	Operators must be familiar with all machinery connected to the Pressco equipment and know how to use emergency stop devices. Note: the emergency stop devices may not be connected directly to the Pressco equipment, but it is important to know how to use them.
	Before putting the Pressco system online, the operator must ensure that all safety devices used with all connected machinery are in place and operational. Do not operate with guards removed.
	The operator must maintain maximum focus on his work and be alert throughout his shift. If this is not the case, immediately inform the shift supervisor.

When carrying out maintenance or repair work:

	Disconnect master switch. For switch locations, refer to the Power Up and Power Down section.
---	---



Before starting the machine, ensure that no person is close to the machine.



If maintenance or repair requires the disconnection or removal of safety or protection systems, this operation must be supervised by authorized personnel who must ensure the prevention of personal injury or damage to the machine. All machine movements must be performed with limited speed and limited movements.



Maintenance or repair work on electrical components must be carried out exclusively by authorized, trained personnel. When running tests with power connected, you must strictly comply with the rules provided.



Personnel working on higher parts of a machine must wear a harness and hook it on to the structure and must always move with extreme caution.



Never perform lubrication or maintenance procedures on mechanical parts with the machine running.

For your safety, do not:



Open safety guards during machine operation



Perform maintenance and repair while the system is running



Lean on the machine



Sit on the machine components



Use the machine for purposes other than those listed in this manual



Modify parts of the machine



Allow unqualified personnel to operate or perform maintenance procedures on the machine

Lifting Heavy Objects



CAUTION - Some components are heavy. Take proper precautions to prevent personal injury or damage to equipment. If you are not capable of lifting the object alone, ask a capable person to help lift the object, or use a mechanical lifting device

The components do not have handles to lift the equipment. Be sure to:

- Lift equipment from the bottom - do not use wires, brackets, nor other protrusions
- Keep fingers away from sensor lenses to keep the equipment clean
- Proceed slowly



WARNING- The Pressco cabinets must NOT be lifted by one person. Use a mechanical lifting device, and ask another person to assist you.



Do not twist your body when moving the load. Instead take small steps with your feet turning until you are in the correct position.

To safely lift equipment:

1. Stand close to the load and center yourself over it with your feet shoulder width apart.
2. Tighten your abdominal muscles.
3. Keeping your back straight, bend your knees and squat down to the floor.
4. Get a good grasp on the load with both hands.
5. Keeping the load close to your body, use your leg muscles to stand up lifting the load off the floor. Your back should remain straight throughout lifting, using only the muscles in the legs to lift the load.
6. To place the load in the appropriate spot, bend at the knees using only your leg muscles to lower the load.

Authorized Users

Trained machine operators, mechanic and electrical maintenance staff, and plant managers are considered authorized users of the Pressco system. These users should carefully read the information contained in this manual. The plant manager must ensure that the safety recommendations included in this manual are observed.



WARNING - Allowing workers who are unfamiliar with the production process to operate the Pressco system could result in hazard risk.

If you are unclear about any part of this manual, contact Pressco Technical Support.



Important - No worker should ever operate the system outside of his/ her own area of competence and responsibility.

Proper Operation: Only one worker is to operate the system at any given time. The correct position for the operator is in front of the user interface monitor or control enclosure (if applicable).

Repairs: Any repair on the system shall be carried out exclusively by Pressco Technology Inc. service personnel or by other service expressly authorized by Pressco Technology Inc.

Spare Parts Usage

The following restrictions apply to replacing parts:



WARNING - Using spare parts that are not designed to Pressco's specifications can compromise the safety and effectiveness of the Pressco system.

- The use of parts that are not within Pressco's design specifications is prohibited. This prohibition applies in particular when the parts involved contain or are connected with safety devices.
- Before resuming production, make sure all safety devices are in working order.

Pressco Technology Inc. shall not be liable in any way if any of the above-described directions are not complied with.

Chapter 2

To obtain a spare parts list, contact the customer service department at Pressco.

Pressco's technicians are available to help customers, in their own plant, to solve any problem that might arise during use and maintenance of the system.

Chapter 3 System Specifications

This instrument has been designed and tested in accordance with Publication EN61010-1 (2010) Safety Requirements for Electrical Equipment for Measurement, Control and Laboratory Use and has been supplied in a safe condition. The instruction documentation contains information and warnings which must be followed by the user to ensure safe operation and to maintain the instrument in a safe condition.

Environmental Conditions

The Intellispec system is designed to be safe in the following environmental conditions:

Note: Please consult Pressco Technology Inc. if your environmental conditions are outside of those listed.

Condition	Specifications
Indoor/ outdoor use	Indoor use only
Altitude	Up to 2000 meters
Operating Temperature	5 °C to 50 °C
Storage Temperature	0 °C to 70 °C
Humidity	Maximum relative humidity 80 % for temperatures up to 31 °C decreasing linearly to 50 % relative humidity at 50 °C
Mains supply	Voltage fluctuations up to ± 10 % of the nominal voltage
Overvoltage protection rating	Transient overvoltage typically present on MAINS supply NOTE: the normal level of transient overvoltages is impulse withstand (over-voltage) category II of IEC 60364-4-443.
Rated pollution degree	This instrument is designed for use in Installation Category II and Pollution Degree 1 as per EN61010-1 and EN60664 respectively.



Warning - This is a Class A product. In a domestic environment this product may cause radio interference in which case the user may be required to take adequate measures.

Sound Pressure Level

The horn on the optional light tree has a maximum 105dB level at 1 meter distance in front of the horn. Use proper hearing protection as specified by your plant safety instructions.

Specifications - Intellispec Series 6

The following sections contain electrical specifications and measurements for components of the Intellispec Series 6 system. Your system contains only the components necessary for your application.

Electrical Specifications - Series 6

230 V: Control Interface Series 6 model 81134

- Volts: 230VAC
- Current:
 - Inspection Module: 4A
 - Air Conditioner: 3.5A
- Frequency: 50/60Hz
- Phases: 1

120 V :Control Interface Series 6 model 81135

- Volts: 115VAC
- Current:
 - Inspection Module: 6A
 - Air Conditioner: 7A
- Frequency: 50/60Hz
- Phases: 1

Dimensions - Series 6 Vision Processor Cabinet

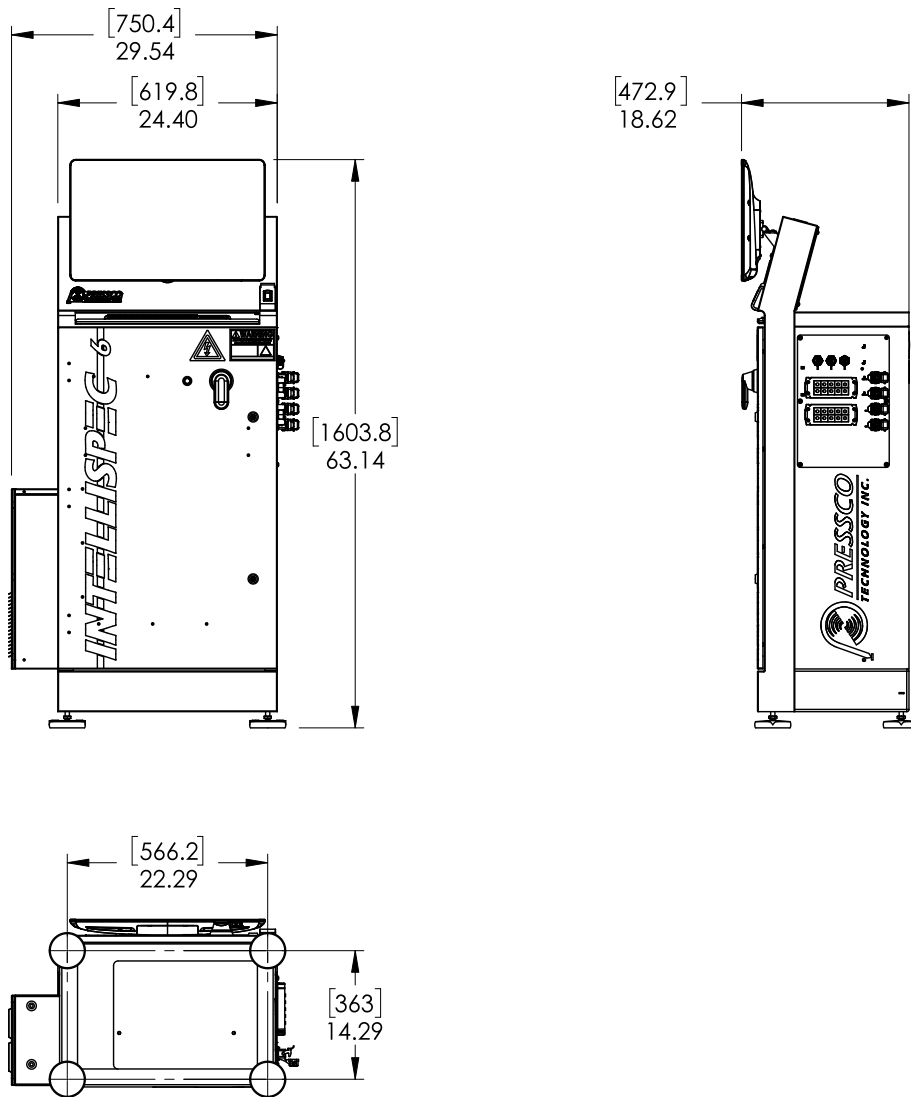

The measurements are in inches. The numbers in brackets are in millimeters.

Chapter 4 Installation

This section contains information about installation requirements and preparations that need to be complete before installing the system.

Shipping and Handling

Pressco Technology Inc. ships unassembled components in packing cases designed to protect the contents during handling and from exposure to weather.

Unless otherwise specified in the contract with the machine order, the Customer shall supply Pressco Technology Inc. with the means and equipment necessary for the unloading, lifting, and handling of machine parts. Pressco Technology Inc. deems it important to have one of their technicians supervise the process of unloading, handling, and lifting the machine. The technician can give useful advice as to the logical sequence in which the components should be unpacked and positioned for ease of assembly.



WARNING - Only qualified personnel must be involved in the operation of unloading, handling, and lifting the machine. Pressco Technology Inc. shall not be liable for damage to components and/or personal injury resulting from the involvement of unauthorized personnel and/or failure to comply with the directions provided in this manual in relation to lifting and transport.



Important - The site supervisor will be responsible for ensuring that all the various mounting phases are carried out safely and in compliance with current regulations.

After the machine is delivered, check for any damage that might have occurred during shipping. In case of damage, contact Pressco Technology Inc.

In handling the machine, always keep it close to the ground.



We recommend using a forklift truck with adequate capacity and forks to suit the weight to be lifted (machine plus packaging).

The dimensions and weight of a crate are listed below. Note that this is the maximum size and weight. The size and weight of the crate may be less depending on your configuration. You may receive multiple crates depending on your configuration.

Size (full Intellispec system)	152.4 cm x 124.46 cm x 152.4 cm (60 x 49 x 60 inches)
Weight (full Intellispec system)	453.592 kg (1000 lbs.)

Weight (Intellispec Vision Processor)	155 kg (340 lbs.)
---------------------------------------	-------------------

Recommendations Prior to Installation

Before the machine is installed, the Pressco installer, together with the Customer (or representative) shall check the following criteria in the environment where the machine is to be installed:

- Work required by contract for the installation of the machine has been carried out
- The plant layout drawing that describes where the machine will be installed is the final drawing agreed to by Pressco Technology Inc.
- The space and height required for installation are actually available
- Only the components included in the installation layout are present in the area where the machine is to be mounted. Ensure no machines or components have been added at a later stage that might hinder mounting or make it more difficult. Should this be the case, immediately contact Pressco's Project Engineering personnel to arrange a suitable solution to the problem.

We recommend the following prior to machine installation:

- Transport the machine in its packaging to the area where it will be installed to minimize possibility of damage
- Carefully remove the packaging material and check components for damage
- Check tightness of mechanical components, as they can loosen during transport
- Prepare the compressed air mains line. Before making final connections, ensure that the pipes are clean and free from any debris.

Utilities to be Supplied by Customer

The following utilities are required to operate the Pressco Intellispec system. Before making connection, make sure the utility matches the technical specifications. More than one connection of the utilities may be required depending on the number of modules installed. Refer to specific wiring diagrams.

Utility	Requirements
Air supply for rejection device	Pipe size must be such that there will be no pressure decrease during machine operation. Air must be dry and free of oil.
Electrical supply	<p>Provide one each electrical socket to comply with:</p> <ul style="list-style-type: none"> • User interface electrical specifications (use the specifications that apply to your system) • Integrated tunnel electrical specifications (if applicable) • Cluster box electrical specifications (if applicable)
Internet connection (optional)	Provide a shielded ethernet cable to use Pressco's remote support through the Internet.

Protective Earthing

This product must be grounded (earthed). If it should malfunction or break down, grounding provides a path of least resistance for electric current to reduce the risk of electric shock.

 **DANGER** - Improper connection of the equipment grounding conductor can result in a risk of electric shock. Check with a qualified electrician or service technician if you are in doubt as to whether the product is properly grounded.

Cord Connected Equipment

The product will be equipped with a supply cord having an equipment grounding conductor and a grounding plug. The plug must be plugged into an appropriate outlet that is properly installed and grounded in accordance with local codes and ordinances.

Do not modify the plug provided with the product - if it will not fit the outlet, have a proper outlet installed by a qualified electrician.

Cable Direct

This product must be connected to a grounded metal, permanent wiring system, or an equipment grounding conductor must be run with the circuit conductors and be connected to the equipment grounding terminal.

Electrical Connection

Make sure that the power outlet voltage matches the voltage required by the machine. Refer to the electrical specifications and wiring diagrams for your system.

⚠ WARNING - Power Switch is the power disconnect device. Do not position the equipment such that access to the disconnect switch is impaired. If not readily accessible (such as within a rack or mounting out of reach), an additional disconnect device should be installed that can isolate the Live and Neutral lines of the mains power supply, whilst leaving the protective earth intact.

Reject Valve Pneumatic Diagram

This diagram shows the reject device connection to the 8-port I/O box. This is for Intellispec systems.

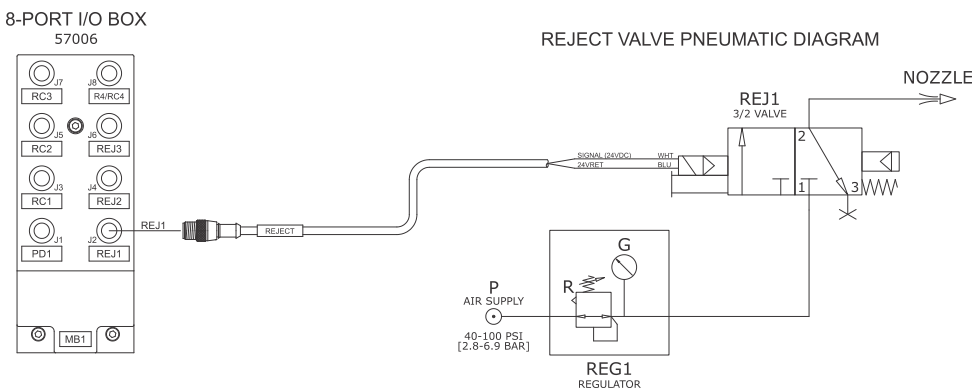

Installation

Pressco Technology Inc. recommends that the machine be installed and assembled by Pressco's specialized technicians. This is of vital importance for correct machine operation.

⚠ WARNING - Pressco Technology Inc. shall not be liable in case of failures or damage to property and/or personal injury resulting from or connected with assembly if this has been carried out by unauthorized personnel, or is not in compliance with the indications given in this manual.

To carry out production and cleaning/ servicing operations, it is important for the machine to have a minimum amount of space all around and away from walls.

Ventilation

Place the Pressco Intellispec components in a position with adequate ventilation to allow proper air flow through the air filters.

Component	Spacing
User Interface	Leave 1 meter [39 inches] clear around machine
Cluster box (not used on all systems)	Leave 100 mm clear in front of the fan and vent

Stability of User Interface

Adjust the feet to level the user interface and ensure stability. Proper leveling can help ensure proper operation. Also refer to the directives in the "[Personnel Safety](#)" on page 12 section.

Commissioning

Before placing the machine into operation, make sure the following checks are completed:

Completed	Yes	No
Positioning and leveling of the unit		
Connection of compressed air line to connection points		
Connection of power supply to vision processor cabinet		
Connection of power supply to cluster box (if applicable)		
Connection of power supply to integrated inspection module(s) if applicable		
Proper wiring from user interface cabinet to sensor module(s) and cluster box (if applicable) using the wiring diagrams		

Chapter 5 Intellispec Control Enclosure and User Interface S6

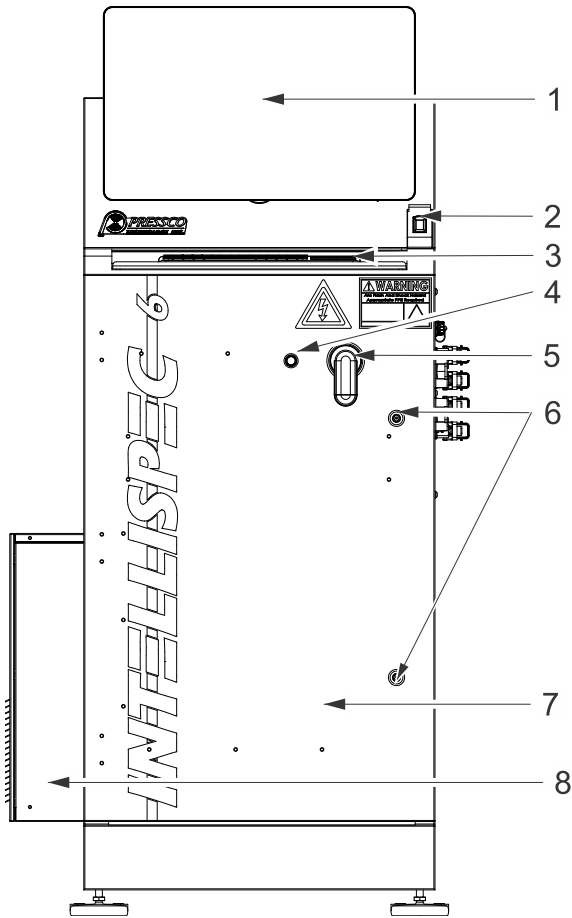

- 1) Touch screen monitor
- 2) Biometric login device
- 3) Keyboard tray
- 4) Power indicator LED
- 5) Power switch
- 6) Locks ("Accessing the Internal Components with the Power Off S6" on page 25)
- 7) Vision processor (inside the control enclosure)
- 8) Air conditioner

USB Ports S6

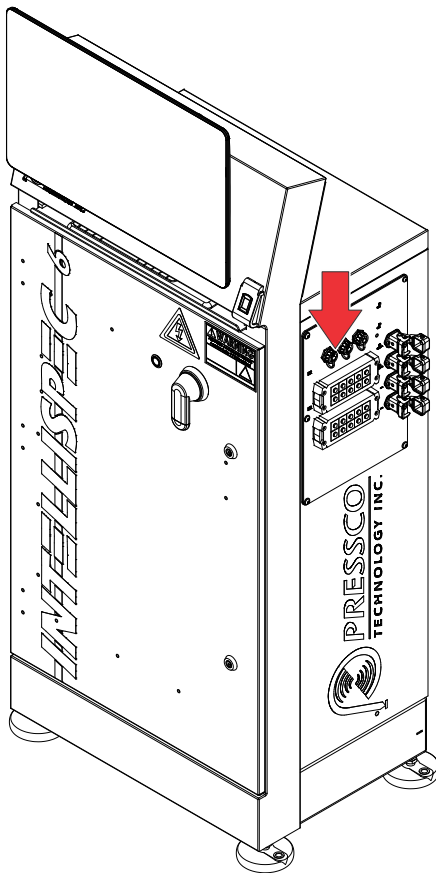

There are USB ports available to back up or transfer data

Use the USB ports when you are:

- Importing or Exporting Part Programs from another system How to Create, Copy, or Import a Part Program
- Exporting user accounts
- Importing user accounts
- Creating a Support Package
- Saving images, especially to send with a support package

 The USB port is not for charging your phone! Only use these ports to import or export data.

Biometric Login Device

The Biometric Identification login device is used to log in and out of the Pressco system. This device is optional and must be purchased with the system.



To log in with this device, press your finger to the device. The following are conditions for use:

- You must use the same finger as initially set up by your administrator
- If you do not know how your account was set up (or which finger you used), contact your administrator
- If, after three tries, the Pressco does not recognize your finger print, you must log in using the On Screen Keyboard (OSK)
- If, after three tries, the Pressco does not recognize your finger print, you must log in using the On Screen Keyboard (OSK)

Power On and Off at the Control Enclosure

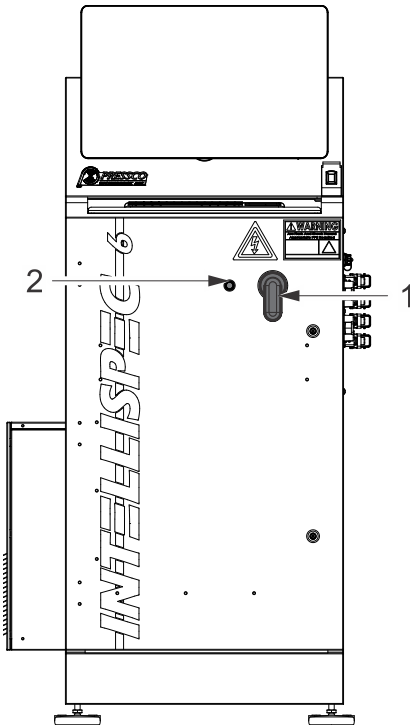

Power on: Turn on the switch [1] on the front of the cabinet. The power indicator [2] will illuminate. The software will start automatically. (You must log in and put the system online to begin inspection)

Note: it takes about a minute for the computer to start after the main power switch is turned ON

Power off: Turn off the switch on the front of the cabinet. The system, including the computer, shuts down. The UPS shuts down.

⚠ WARNING - When you shut down power using this switch, there is still voltage present on the UPS inside the unit until it discharges.

! Important - If you want to restart the system, turn off the power, let the software and components completely shut down, and leave the power off for about one minute before turning it back on. This allows the electronic components to correctly reset.

Accessing the Internal Components with the Power Off S6

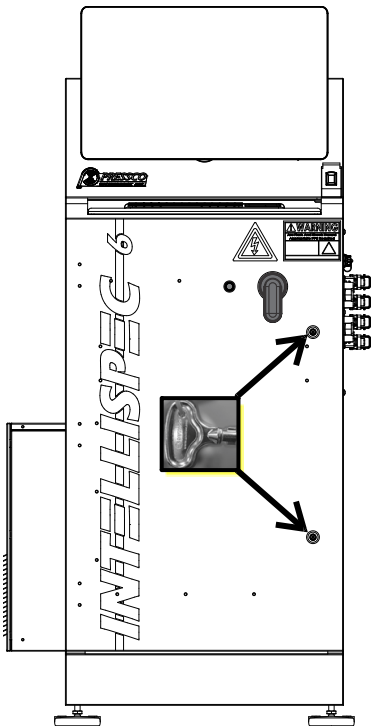

To access the components inside of the control cabinet, you will need the keys (supplied by Pressco).

⚠ WARNING - When the system is powered down, there is still voltage present at the UPS. Only **AUTHORIZED PERSONNEL** should attempt to open the system. We recommend that only **AUTHORIZED PERSONNEL** have access to the keys.

Lockout Procedure

To prevent power from being applied while the cabinet door is open:

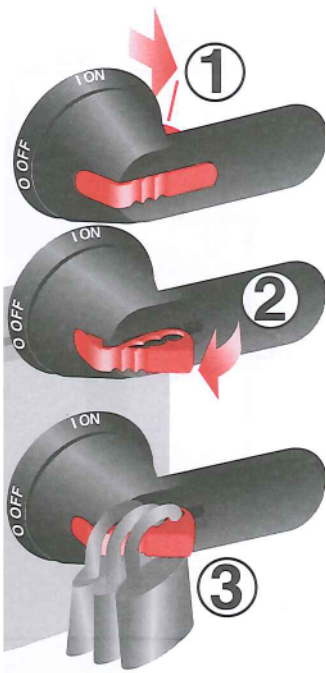

1. Make sure the handle is in the OFF position
2. Push the red piece of the handle out from the back
3. Secure up to three locks

Accessing the Internal Components with the Power On

The disconnect switch has an override feature allowing you to open the cabinet door while the switch is in the ON position.

⚠ WARNING - Only AUTHORIZED SERVICE PERSONNEL should access the inside of the computer while the power to the unit is still applied.

1. Use a small, blunt tool to press the small button on the left side of the handle. A 3/32" or 2.5mm allen key works best, but you can use a ball point pen.

⊘ Do not use a sharp tool to press the button.

2. Open the cabinet door.

⚡ Warning - live voltage is present within the cabinet.



Rebooting the Intellispec System

You may need to reboot the system if power or communication has been lost between the Vision Processor and the Cluster Box (if applicable) or inspection modules.

Symptoms may include that the inspection module light has stopped flashing, and the system is no longer taking pictures. Rebooting the system will reconnect the Vision Processor with the Part Tracker.

Note: if the power to both the Vision Processor UPS and the Cluster box is interrupted for more than two minutes, the software will automatically shut itself down and then shut down the Vision Processor PC. The software will restart. You will just need to log in and put the system back online.

Restarting the system

If your system has stopped communicating, or the software has stopped operating, we recommend that you restart the whole system. This will reset the software, the inspection module, and all the communication devices of the system.

To restart the system:

1. Turn off the main power switch (DISC 1). The system will shut down, including a controlled shut down of the software.
2. Wait until the software and all the components have shut down, and then wait for about 40 more seconds to allow the electronic components to reset.
3. Turn on the main power switch (DISC 1). The system will start, and the Intellispec software will load. Log in to begin using the system.

Note: The system restart takes several minutes to complete.

If the system restart does not fix the problem, try one of the solutions below, or contact Pressco. (How to Contact Pressco)

Restarting the Software Application

You may need to restart the software if you see a software error that, for some reason, may not have been cleared by restarting the entire system.



You must have proper user permissions to exit the software. This prevents unauthorized system shut-downs. Contact your system administrator if you need user permissions.

Important - When restarting the software, it is important to choose the correct option from the Shut Down System menu. Only select Shut Down Intellispec and Restart Computer as described below.

To restart the Intellispec software:

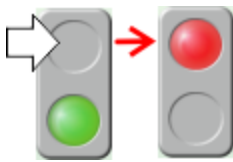
1. Log in.
2. Take the system offline. (Repeat for all lanes if necessary)



3.   Exit the software: Home | Tools | Shut Down Intellispec and Restart Computer.
4.  Click the OK button. The Intellispec software and computer shuts down and restarts. Your system may be configured to go online at startup. Otherwise, the software will come up in System Overview mode where you can log in to continue operating the system.

Rebooting the computer

If restarting the software application does not clear the errors, or the software does not restart, or you see the "System in Transition" message, try rebooting the computer.

To reboot the computer:

1. Press Ctrl + Alt + Delete on the keyboard.
2. Use the Log Off option to log off of Intellispec.
3. At the Windows Login Prompt, enter "pvpass" as the password for the Intellispec user account. Once login is complete the application software will be launched.

Note: The system reboot takes several minutes to complete.

Chapter 6 Components and Interconnect Diagrams

External Connections

The connectors are on the side of the Intellispec Series 6 cabinet.

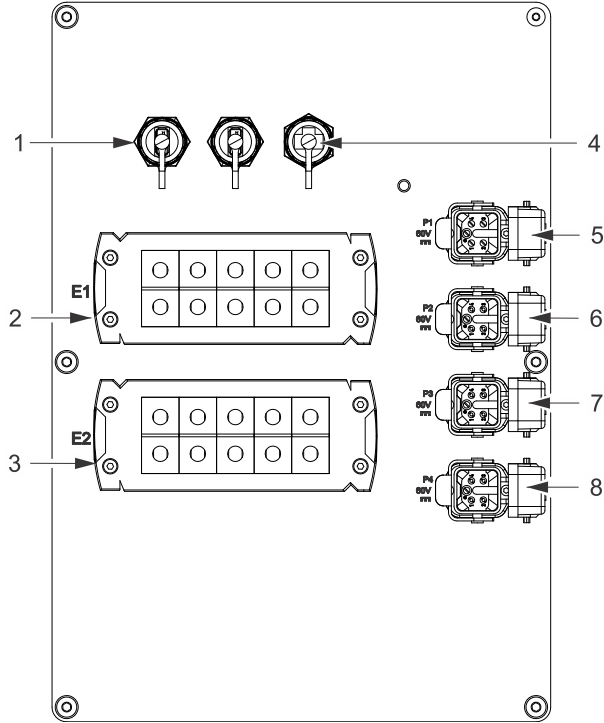

- 1) USB1 and USB2 - for data transfer
- 2) E1 block connector - inspection module connections
- 3) E2 block connector - inspection module connections
- 4) Ethernet connector
- 5-8) P1 - P4 connectors - 60 VDC out to inspection modules

Light Tree S6

The lights on the optional light tree will turn on, off, or blink depending on status of certain hardware. Each lane has its own light tree.

Note: the light tree on your system may look different than the picture shown

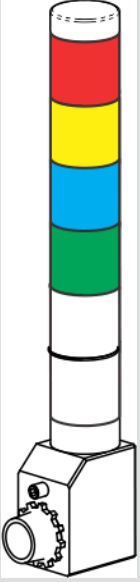
	Light color	Condition	What it means
	Red	On - steady	Alarm condition
	Red	On - blinking	Part tracker board lost communication with the host PC or has an error and needs to initiate an alarm
	Red	Off	No alarm (OK)
	Amber	On - steady	Warning alarm condition
	Amber	Off	No warning (OK)
	Amber	0.5 second flash	System automatically resets Asynchronous Correlation FIFO (not used in all systems)
	Blue	On	Not assigned
	Blue	Off	Not assigned
	Green	On - steady	Lane is online
	Green	Off	Lane is offline
	White	On - steady	Power On (Part tracker board has power)
	White	Off	Power Off (Part tracker board has no power)

Internal Components

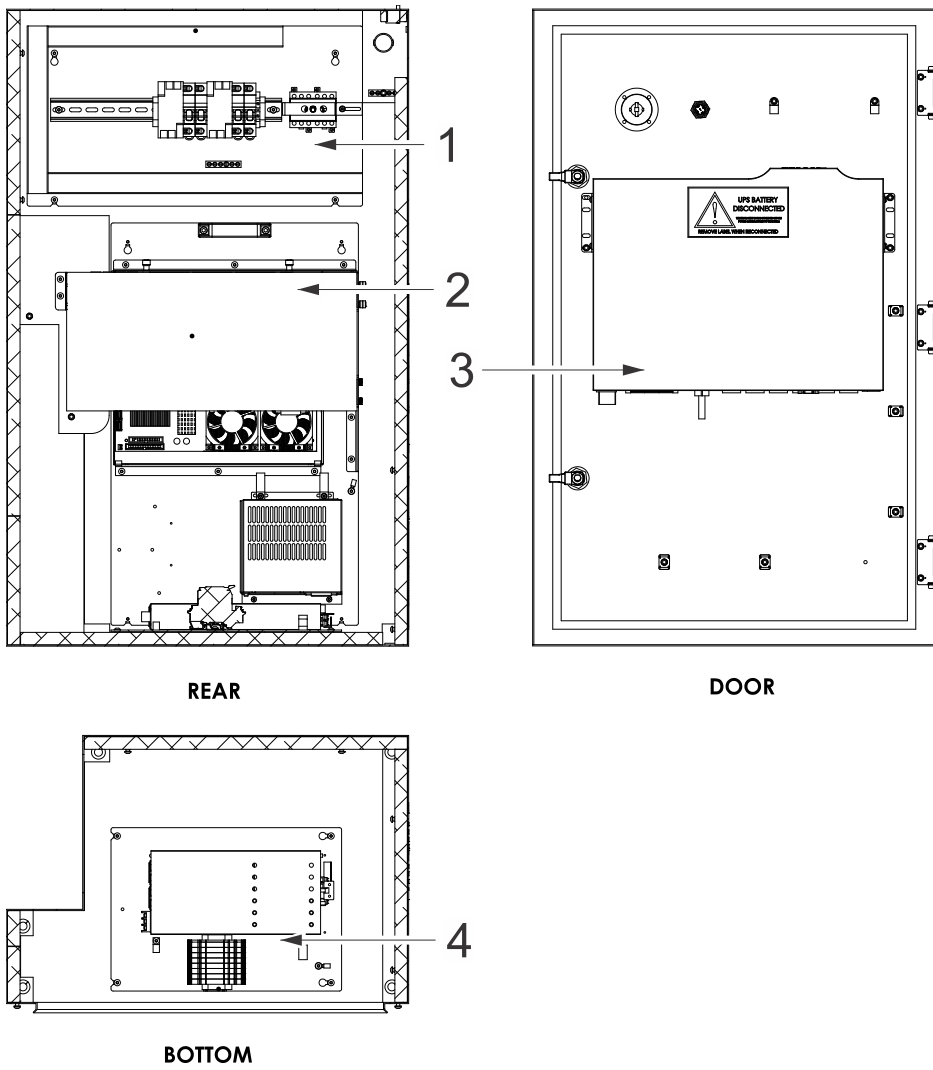

- 1) Power Entry Panel, including terminal block TB1
- 2) Vision Processor Assembly
- 3) UPS (Uninterruptible Power Supply)
- 4) DC Power Panel, including terminal block TB2

TB1 Terminal Block Assembly 120V

This terminal block is located on the Power Entry Panel.

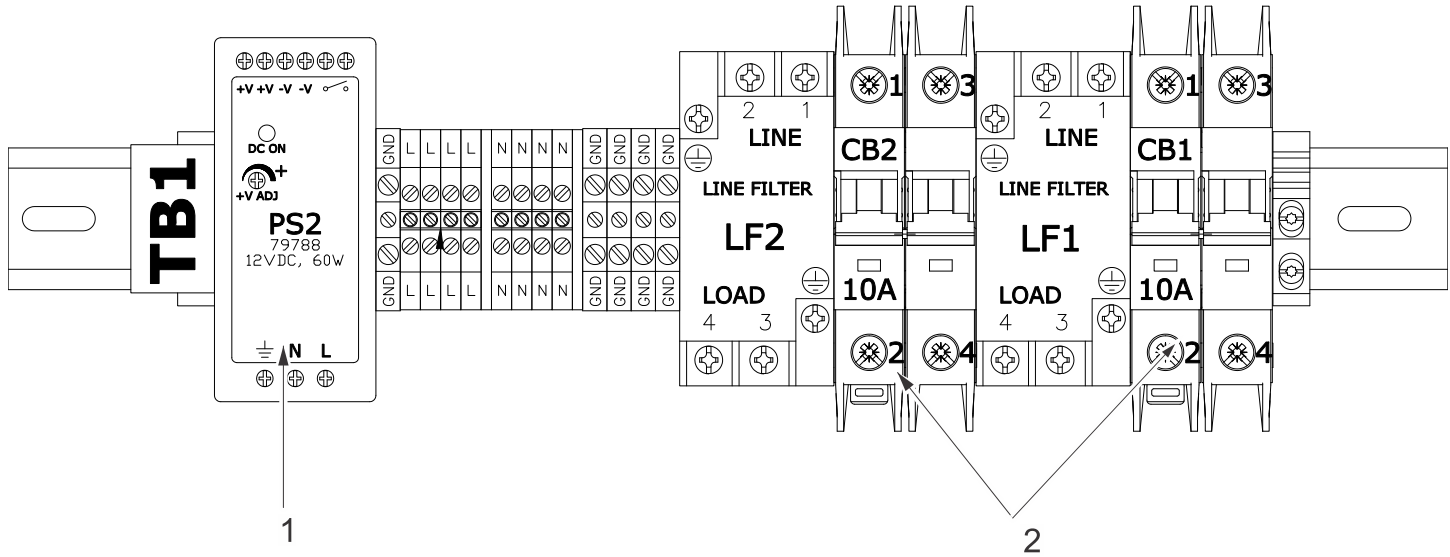

- 1) PS2: POWER SUPPLY 12VDC 60WATT DIN MOUNT 110/230 VAC
- 2) CB1, CB2: CIRCUIT BREAKER 10A 2POLE UL489

TB1 Terminal Block Assembly 230V

This terminal block is located on the Power Entry Panel.

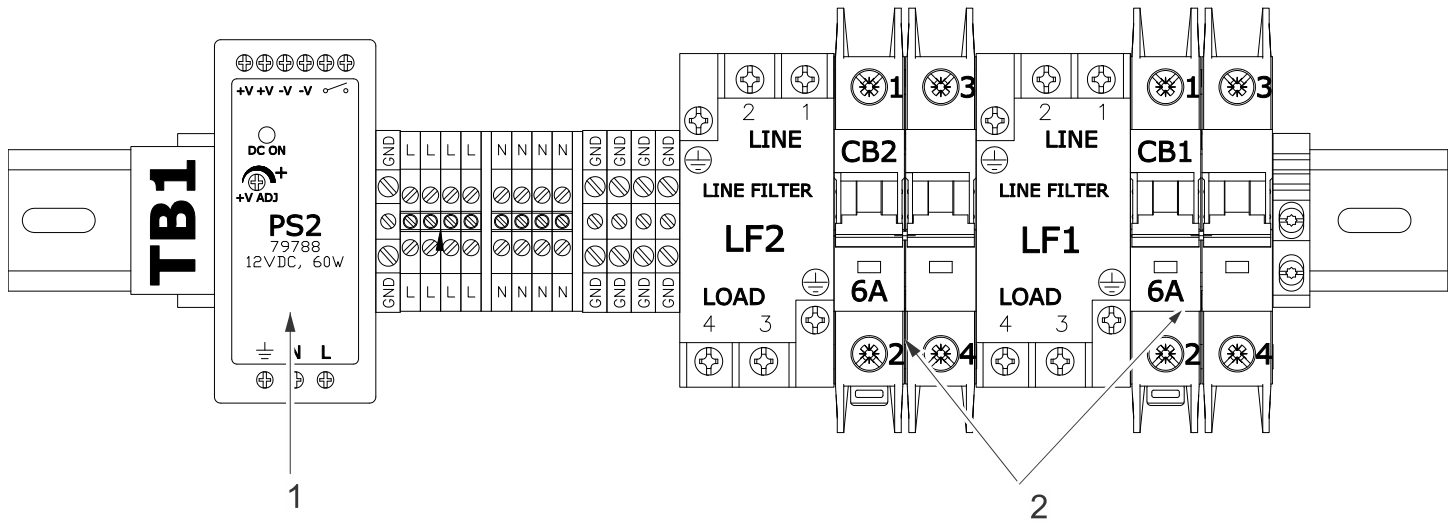

- 1) PS2: POWER SUPPLY 12VDC 60WATT DIN MOUNT 110/230 VAC
- 2) CB1, CB2: CIRCUIT BREAKER 6A 2POLE UL489

DC Power Panel

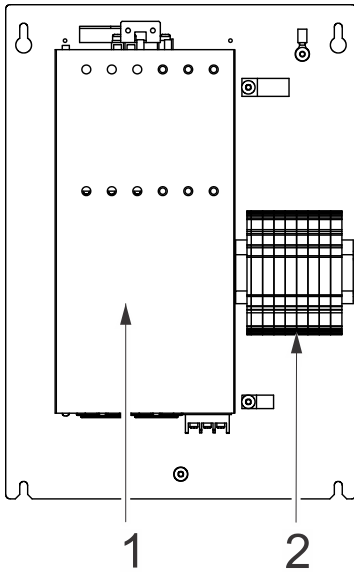

1) POWER SUPPLY 60VDC 1000W, 85-264VAC 47-440HZ

2) TB2 DC POWER S6

Fuse Replacement

The fuses are located in Terminal Block TB2, which is located on the bottom panel of the control enclosure



WARNING - For continued protection against fire hazard, replace fuses only with the same type and ratings. The use of other fuses or materials is prohibited.



WARNING - Disconnect the product from the mains supply before replacing the fuse(s).

For fuse rating, refer to the table below.

See Wiring Diagram - "Wiring Diagram F1959W Sheet 5 of 6" on page 38

Pressco part number	Fuse	Value	Location
77915 Fuse Kit	FU1 - FU8	FUSE 5A TIME DELAY 5X20MM	bottom panel

Wiring Diagram F1959W Sheet 5 of 6

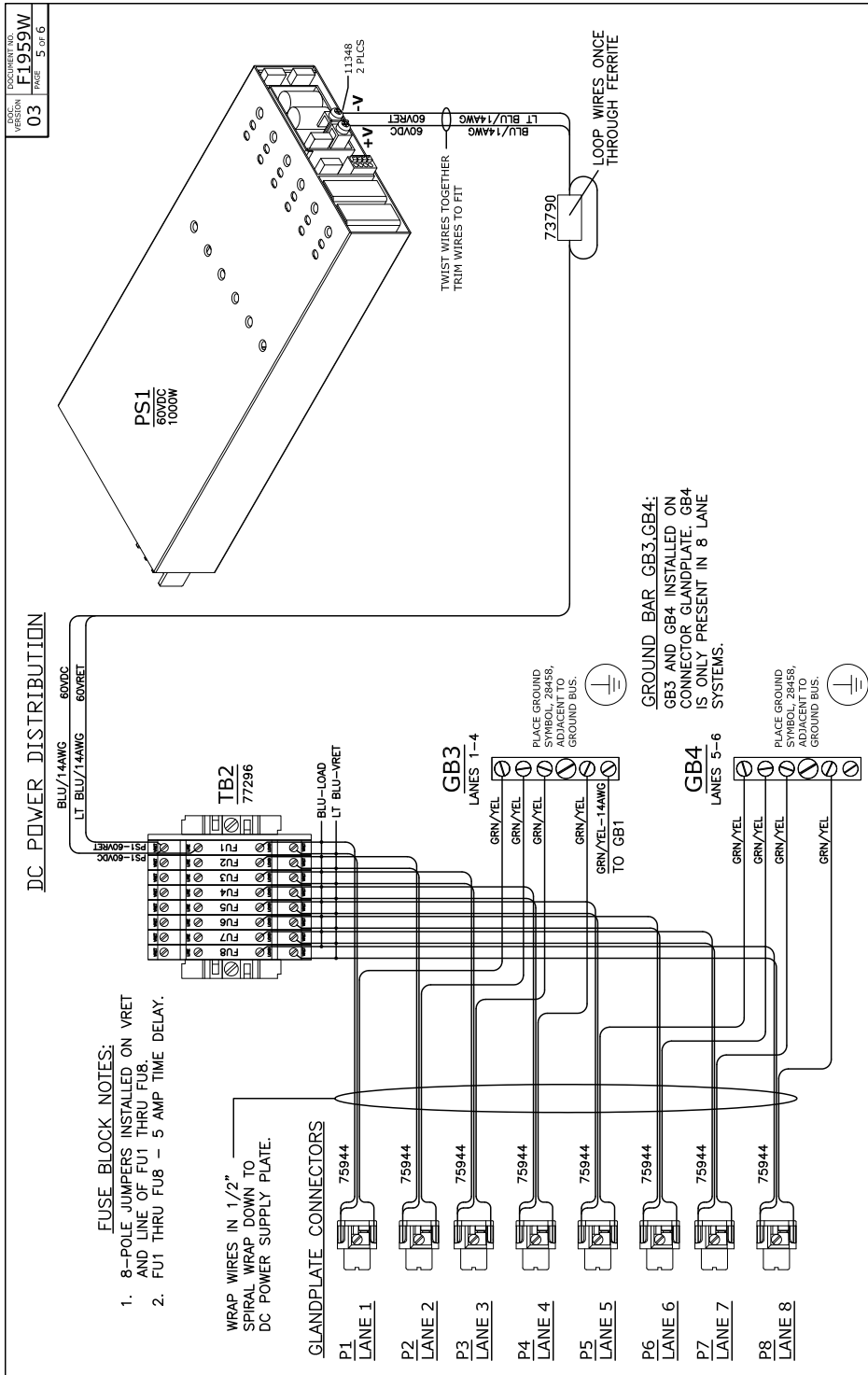

Wiring Diagram F1959W Sheet 6 of 6

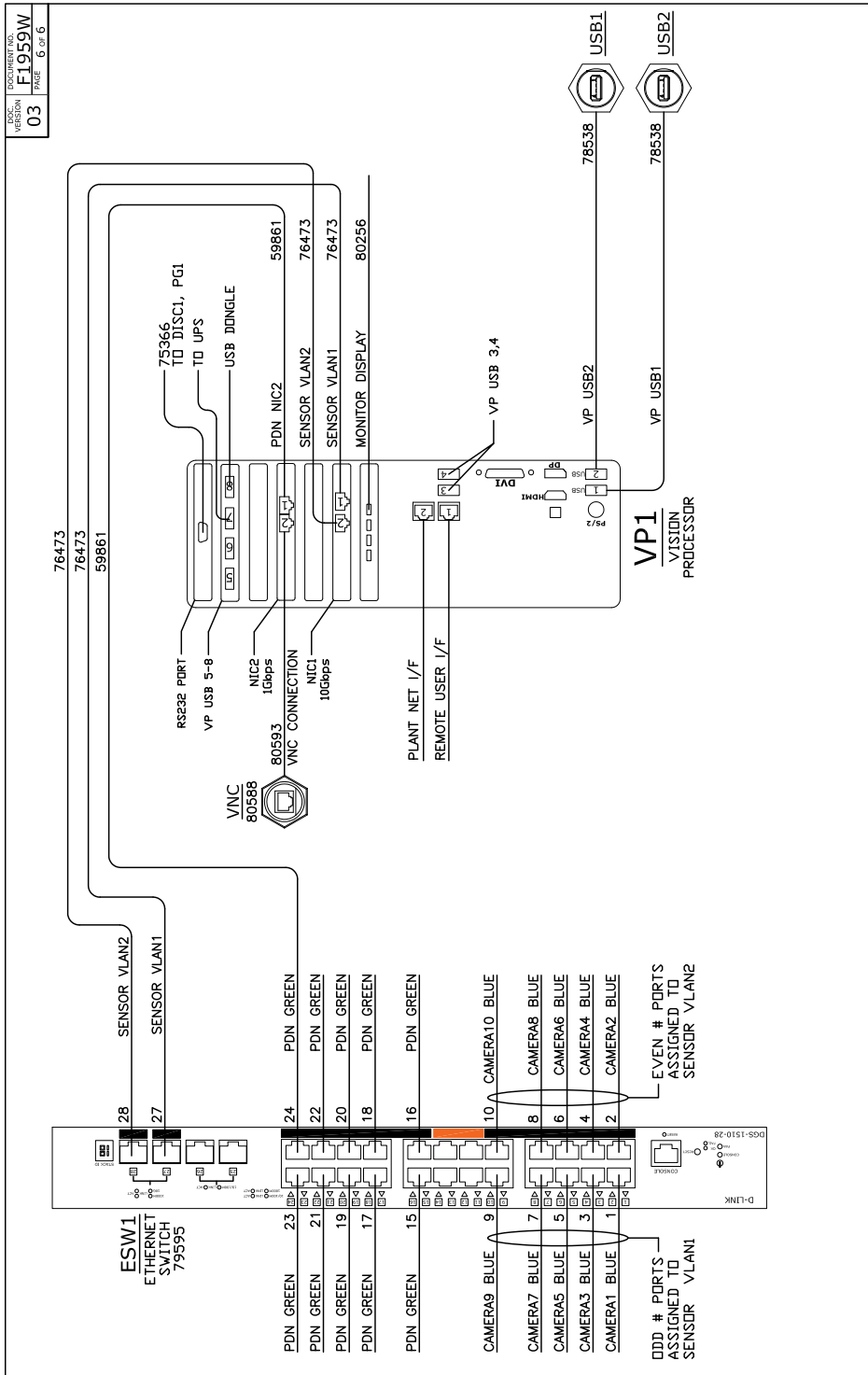

Chapter 8 Extended I-O S6

This section contains information about the optional Extended I/O board in Intellispec Series 6 systems.

Note: In some systems, such as FHCP inspection systems, the Extended I/O board is always included (not optional).

Extended I-O Board S6

This optional module provides additional input and output ports for communicating with the Intellispec Series 6 system. The board may be installed within a cluster box or within an inspection module. The board is connected to the lane's Part Tracker board via a ribbon cable.

Note: Each Extended I/O board handles only one lane.
Note: Extended I/O is not available with an Embedded Cluster Box.

Some signals must be enabled in the software through the "Extended I-O Configuration" on page 50.

Below is the layout for the Extended I/O board. "Extended I-O Signals S6" on the next page

Switch SW1 selects Intellispec 24V power supply or User 24V power supply. "Extended I-O Switch SW1 Selection" on page 48

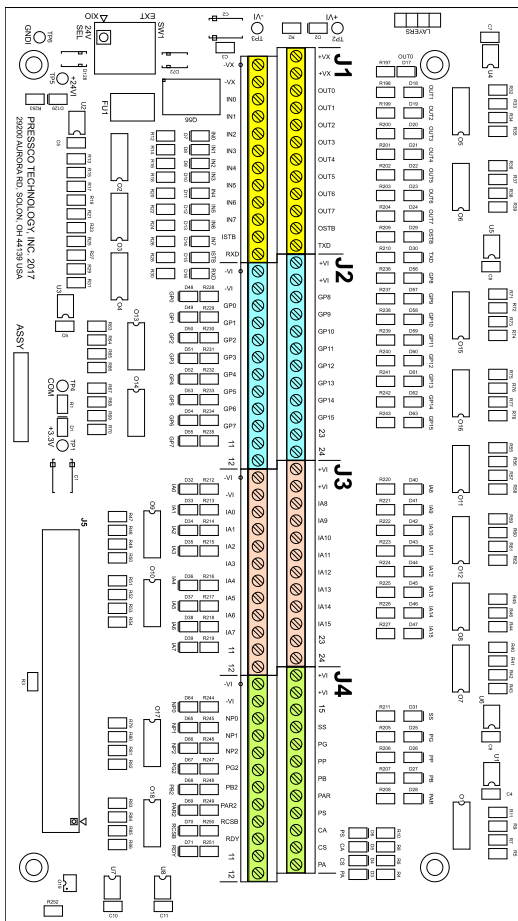

Extended I-O Signals S6

Switch SW1 selects Intellispec 24V power supply or User 24V power supply.

Labels used on the board: Series 6

Signal	Label	Signal	Label
User +24VDC	+VX	System State	SS
User 24VRET	-VX	Part Present	PP
+24VDC	+VI	Part Good	PG
24VRET	-VI	Part Bad	PB
Generic Input n	INn	Part at Reject	PAR
Generic Output n	Outn	Part Good 2	PG2
Input Strobe	ISTB	Part Bad 2	PB2
Output Strobe	OSTB	Part at Reject 2	PAR2
Group n	GPn	Print Statistics	PS
Inspection Alarm n	IAn	Clear Alarms	CA
Not Processed n	NPn	Clear Statistics	CS
Reject Confirm Sensor Blocked	RCSB	Preform Alarm	PA
RS232 Transmit	TXD	System Ready	RDY
RS232 Receive	RXD		

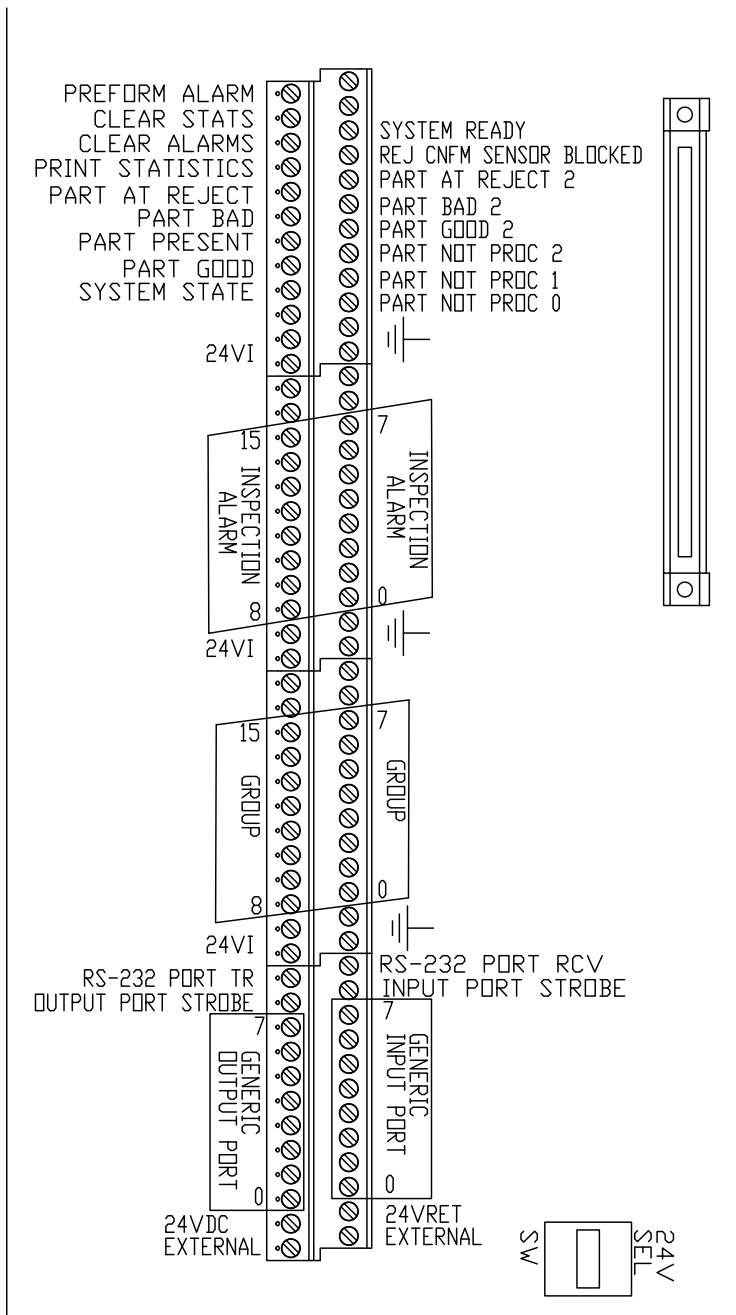

Note: some signals are not currently used

All Extended I/O inputs are PNP. Outputs are selectable to be either open collector or open emitter. However, that selection applies to ALL output signals.

The input and power LEDs are visual indicators. The maximum current output is 50mA. See also information about Extended I/O circuits.

Terminal	Signal and Indicator LED label	Input (I) or Output (O)	Comments
J1-1	User 24VRET (-VX)		
J1-2	User 24VRET (-VX)		

Terminal	Signal and Indicator LED label	Input (I) or Output (O)	Comments
J1-3	Generic Input 0 (IN0)	I	Port 0 and Port 1 used in Remote Part Program Switching Generic Input bits may be used for Auto-Learn or Alternate Part Processing
J1-4	Generic Input 1 (IN1)	I	
J1-5	Generic Input 2 (IN2)	I	
J1-6	Generic Input 3 (IN3)	I	
J1-7	Generic Input 4 (IN4)	I	
J1-8	Generic Input 5 (IN5)	I	
J1-9	Generic Input 6 (IN6)	I	
J1-10	Generic Input 7 (IN7)	I	
J1-11	Input Strobe (ISTB)	I	
J1-12	RS232 RX (RXD)	I	
J1-13	User +24VDC (+VX)		
J1-14	User +24VDC (+VX)		
J1-15	Generic Output 0 (OUT0)	O	
J1-16	Generic Output 1 (OUT1)	O	
J1-17	Generic Output 2 (OUT2)	O	
J1-18	Generic Output 3 (OUT3)	O	
J1-19	Generic Output 4 (OUT4)	O	
J1-20	Generic Output 5 (OUT5)	O	
J1-21	Generic Output 6 (OUT6)	O	
J1-22	Generic Output 7 (OUT7)	O	
J1-23	Output Strobe (OSTB)	O	Pulsed When data of Generic Output Port (0-7) is set
J1-24	RS232 TX (TXD)	O	

Terminal	Signal and Indicator LED label	Input (I) or Output (O)	Comments
J2-1	24VRET (-VI)		
J2-2	24VRET (-VI)		
J2-3	Group 0 (GP0)	O	Pulses for 12 ms when an inspection fails in the user-defined group (online mode only) Walk By Setup
J2-4	Group 1 (GP1)	O	
J2-5	Group 2 (GP2)	O	
J2-6	Group 3 (GP3)	O	
J2-7	Group 4 (GP4)	O	
J2-8	Group 5 (GP5)	O	
J2-9	Group 6 (GP6)	O	
J2-10	Group 7 (GP7)	O	

Chapter 8

Terminal	Signal and Indicator LED label	Input (I) or Output (O)	Comments
J2-11	no connection		
J2-12	no connection		
J2-13	+24VDC (+VI)		
J2-14	+24VDC (+VI)		
J2-15	Group 8 (GP8)	O	See comments for Group 0 - 7 above
J2-16	Group 9 (GP9)	O	
J2-17	Group 10 (GP10)	O	
J2-18	Group 11 (GP11)	O	
J2-19	Group 12 (GP12)	O	
J2-20	Group 13 (GP13)	O	
J2-21	Group 14 (GP14)	O	
J2-22	Group 15 (GP15)	O	
J2-23	no connection		
J2-24	no connection		

Terminal	Signal and Indicator LED label	Input (I) or Output (O)	Comments
J3-1	24VRET (-VI)		
J3-2	24VRET (-VI)		
J3-3	Inspection Alarm 0 (IA0)	O	Set when the associated alarm condition occurs and stays active until the alarm is cleared Lane Alarm Configuration and Sensor Alarm Configuration
J3-4	Inspection Alarm 1 (IA1)	O	
J3-5	Inspection Alarm 2 (IA2)	O	
J3-6	Inspection Alarm 3 (IA3)	O	
J3-7	Inspection Alarm 4 (IA4)	O	
J3-8	Inspection Alarm 5 (IA5)	O	
J3-9	Inspection Alarm 6 (IA6)	O	
J3-10	Inspection Alarm 7 (IA7)	O	
J3-11	no connection		
J3-12	no connection		

Chapter 8

Terminal	Signal and Indicator LED label	Input (I) or Output (O)	Comments	
J3-13	+24VDC (+VI)			
J3-14	+24VDC (+VI)			
J3-15	Inspection Alarm 8 (IA8)	O	See comments for Inspection Alarm 0-7 above	
J3-16	Inspection Alarm 9 (IA9)	O		
J3-17	Inspection Alarm 10 (IA10)	O		
J3-18	Inspection Alarm 11 (IA11)	O		
J3-19	Inspection Alarm 12 (IA12)	O		
J3-20	Inspection Alarm 13 (IA13)	O		
J3-21	Inspection Alarm 14 (IA14)	O		
J3-22	Inspection Alarm 15 (IA15)	O		
J3-23	no connection			
J3-24	no connection			

Terminal	Signal and Indicator LED label	Input (I) or Output (O)	Comments
J4-1	24VRET (-VI)		
J4-2	24VRET (-VI)		
J4-3	Not Processed 0 (NP0)	O	Pulses for 12 ms when a part is not processed due to a system malfunction (online mode only)
J4-4	Not Processed 1 (NP1)	O	
J4-5	Not Processed 2 (NP2)	O	
J4-6	Part Good 2 (PG2)	O	Group B outputs. See Extended I/O Configuration
J4-7	Part Bad 2 (PB2)	O	
J4-8	Part at Reject 2 (PAR2)	O	
J4-9	Reject Confirm Sensor Blocked (RCSB)	O	Reject confirm sensor signal pulse width exceeding programmed limit
J4-10	System Ready (RDY)	O	Steady state ON or OFF 24V.

Terminal	Signal and Indicator LED label	Input (I) or Output (O)	Comments
			ON = lane is online, no critical alarms are triggered, and no lost communication.
			OFF = lane is offline, a critical alarm has been triggered, or communication is lost (example: part tracker communication lost).
J4-11	no connection		
J4-12	no connection		
J4-13	+24VDC (+VI)		
J4-14	+24VDC(+VI)		
J4-15	no connection		
J4-16	System State (SS)	O	Indicates whether the lane is online or offline. Online = active. Offline = inactive.
J4-17	Part Good (PG)	O	Pulses for 12 ms for each part declared good by the inspection
J4-18	Part Present (PP)	O	Pulses for 12 ms when the part present sensor detects a part
J4-19	Part Bad (PB)	O	Pulses for 12 ms for each part declared bad by the inspection
J4-20	Part at Reject (PAR)	O	Pulses for 12 ms for each part that crosses the reject point (online mode only)
J4-21	Print Statistics (PS)	I	Prints the lane statistics to currently configured printer or file Schedule Reports
J4-22	Clear Alarms (CA)	I	Clears the lane alarms
J4-23	Clear Statistics (CS)	I	Clears the lane statistics
J4-24	Preform Alarm (PA)	I	Used only in special applications. Activated by the Preform Material Handling system.

Test Points

Function	Test Point
+3.3V	TP1
+3.3V Gnd	TP4
+24VDC (+VI)	TP2
24VRET (-VI)	TP3
+24VI	TP5
GNDI	TP6

Extended I-O Switch SW1 Selection

Switch SW1 – 24VDC Selection:

SW1 has three positions:

- XIO – In the XIO position 24VDC is supplied by the Intellispec power supply. 24VDC will be on terminals labeled +VI and 24VRET will be on terminals labeled –VI at J2, J3 and J4. Devices requiring 24VDC power should be connected to the +VI and –VI terminals. The terminals labeled +VX and –VX at J1 are not used. The 24VDC indicator LED D2 will be on if SW1 is in this position. There is no isolation from the Intellispec power supply. See Figure 1.
- CTR – In the center position there is no connection to a 24VDC source. There will be no voltage present at the terminals labeled +VI and –VI at J2, J3 and J4. The CTR position is not labeled on the PCB. The 24VDC indicator LED D2 will be off if SW1 is in this position. See Figure 2.
- EXT – In the EXT position 24VDC is supplied by an external 24VDC power supply. The external 24VDC must be connected to the +VX terminals and the external 24VRET must be connected to the –VX terminals. Devices requiring 24VDC power should be connected to the +VI and –VI terminals. The 24VDC indicator LED D2 will be on if SW1 is in this position. The external power supply and signals are isolated from the Intellispec power supply. See Figure 3.

Note: 24VDC LED D129 is on to indicate 24VDC is supplied through the ribbon cable from the part tracker board.



WARNING: Do not connect an external power supply to terminals labeled +VI or –VI.

Figure 1 - SW1 in the XIO Position

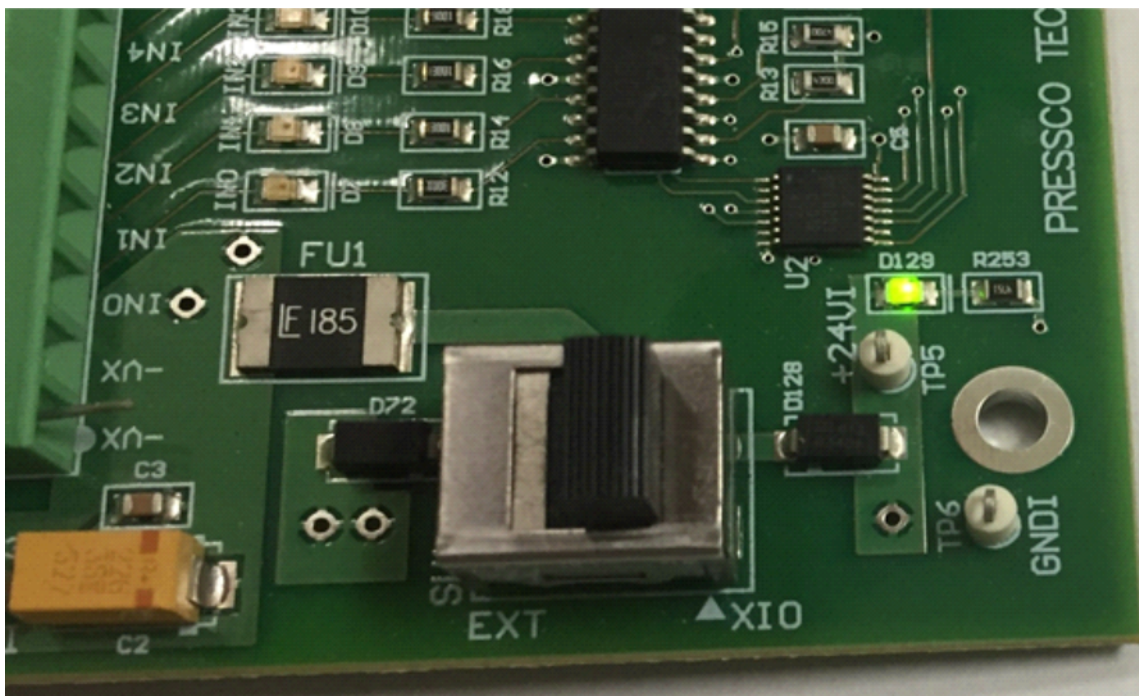

Figure 2 - Switch SW1 in the CTR position

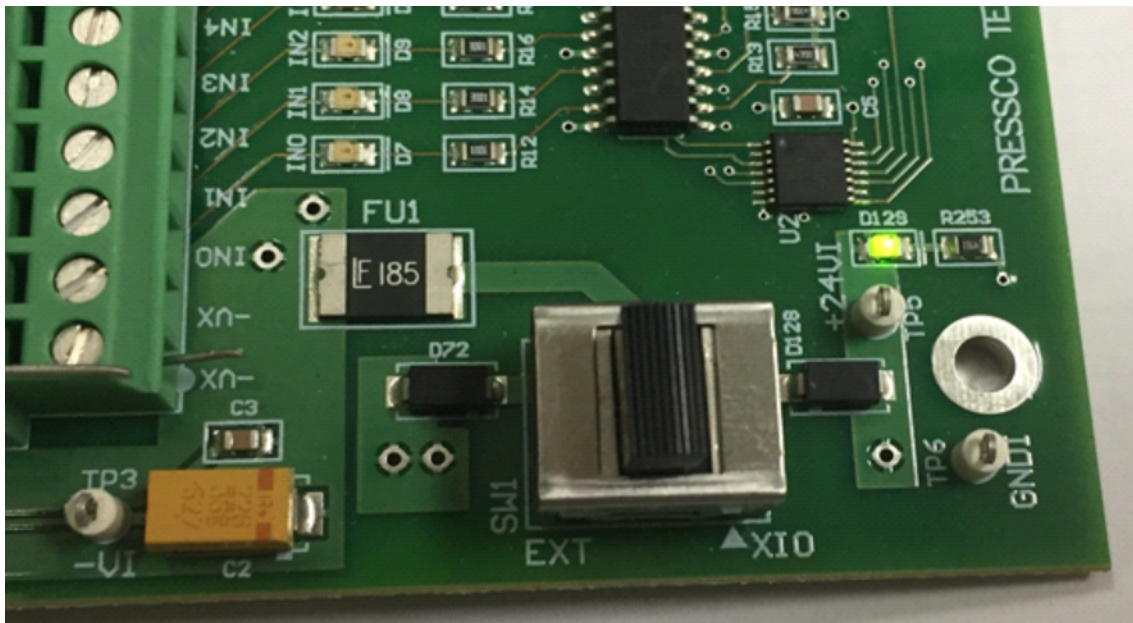
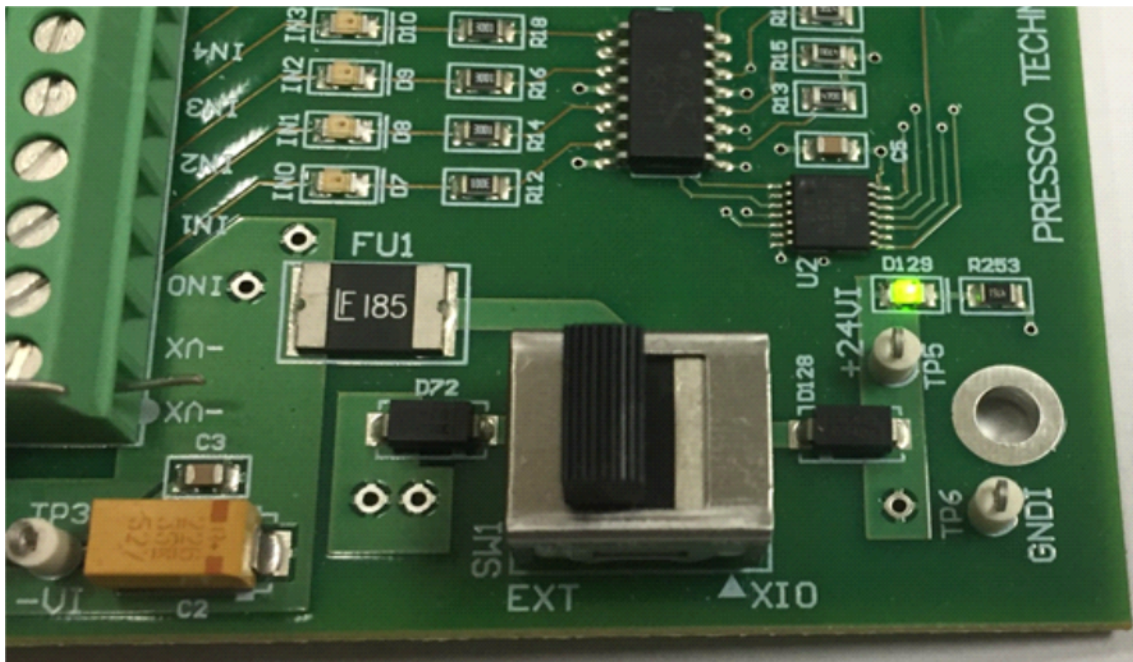

Figure 3 - Switch SW1 in the EXT position



Extended I-O Circuits S6

The following illustrations show typical input and output circuits you can use to communicate with your plant's PLC, or to connect external LEDs or light trees.

Specifications:

Chapter 8

- Minimum dwell time of the input device is 1.1 ms
- Maximum output load is 50 mA
- Default value of output pulse is 12ms. Some output signals, such as alarms, must be cleared on the Intellispec before they turn off.

Default timing of pulsed output

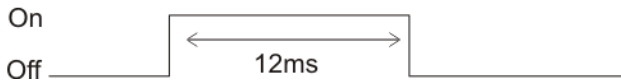

The following illustration shows a typical circuit that can be used to clear alarms.

CLEAR ALARMS - INPUT

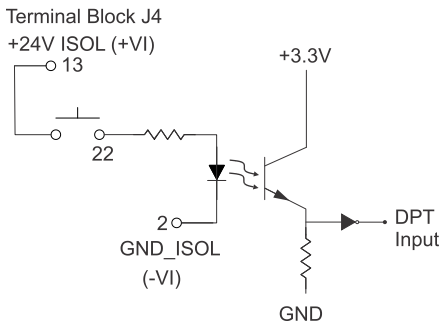

The following illustration shows a typical circuit that can be used for a group output.

GROUP 1 - OUTPUT

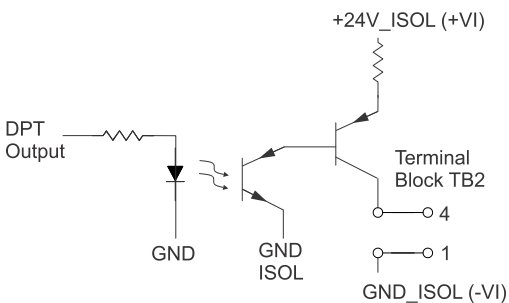

Extended I-O Configuration

Enable input or output signals to perform a function on the Intellispec system or monitor the production lane in your plant. These settings must be done for each Extended I/O board for each lane.

See also the sections about Extended I/O and Extended I/O Signals in the Intellispec Hardware Guide.



To get to this screen: From Lane or Sensor Overview mode, select Tools | Hardware Setup | Extended I/O Configuration.

This screen displays some of the inputs and outputs on the optional extended I/O board.

If one of the extended I/O ports is used it must be enabled here in the software, and the hardware must be connected appropriately.

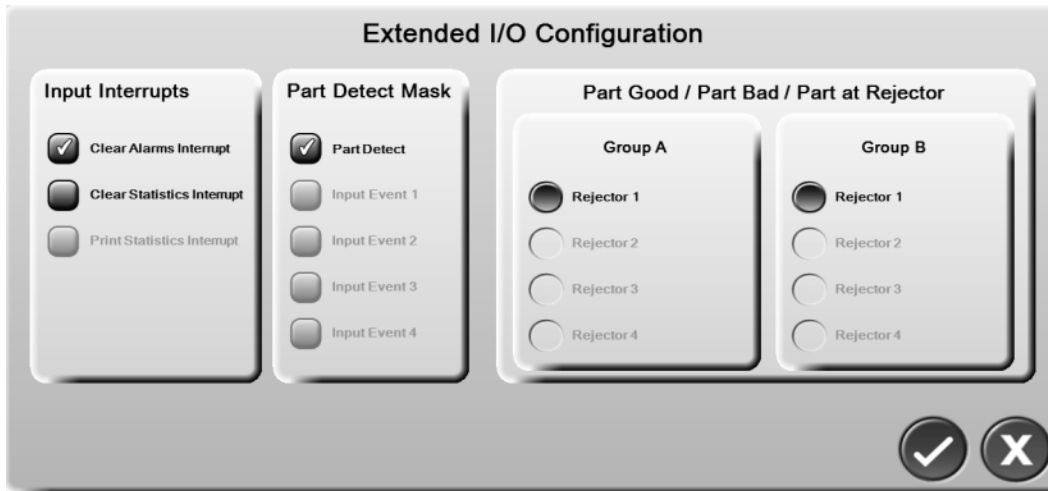

Input Interrupts

These signals produce an input pulse to the Intellispec to perform the following functions.

Clear Alarms Interrupt Clear the lane alarms.

Clear Statistics Interrupt Clear the lane statistics.

Print Statistics Interrupt Print the lane statistics to the currently configured printer or file. See also Schedule Reports.

Part Detect Mask

Choose which Part Detect or other input events to trigger the Part Present output on the Extended I/O board. This is an OR function. Any enabled Part Detect signal or Input Event that goes active will activate the Extended I/O Part Present output.

Part Detect The signal goes active when the sensor detects a part.

Input Event N The Part Tracker board accepts up to five* input events (Part detectors or other sensors). Part tracking is always controlled by the Part Detect signal (Input Event 0). You might use other input events (1 - 4) in your system to trigger the Part Present output signal. *Only if your system has an 8-channel Part Tracker board. If your system has a 2-channel Part Tracker board, then only one Part Detect signal is used. The other input events are not available.

Part Good/ Part Bad/ Part at Rejector

Choose which rejector signal to activate the Part Good, Part Bad, and Part at Rejector signals on the Extended I/O board. After a part is inspected, the system determines whether the part is good or bad. As the part passes by Rejector 1, 2, 3, or 4, the Part Good/ Part Bad/ and Part at Rejector signals are activated on the Extended I/O board. There are two groups of Part Good/ Part Bad/ and Part at Rejector signals - Group A and Group B. You choose which rejector is associated with Group A and/or Group B. You can have both groups associated with the same rejector, if desired. See Extended I/O signals in the Intellispec hardware guide

Note: If your system has a 2-channel Part Tracker board, then the lane has up to two rejectors. If your system has an 8-channel Part Tracker board, then the lane has up to four rejectors.

Example 1 below

Group A is triggered when the part passes Rejector 2, and Group B is triggered when the part passes Rejector 4. The illustration below shows a basic block diagram with a conveyor with four rejectors. Those rejectors output a signal to the Extended I/O board, based on the Extended I/O configuration.

R = Rejector

PG = Part Good signal, Group A and Group B

PB = Part Bad signal, Group A and Group B

PaR = Part at Reject signal, Group A and Group B

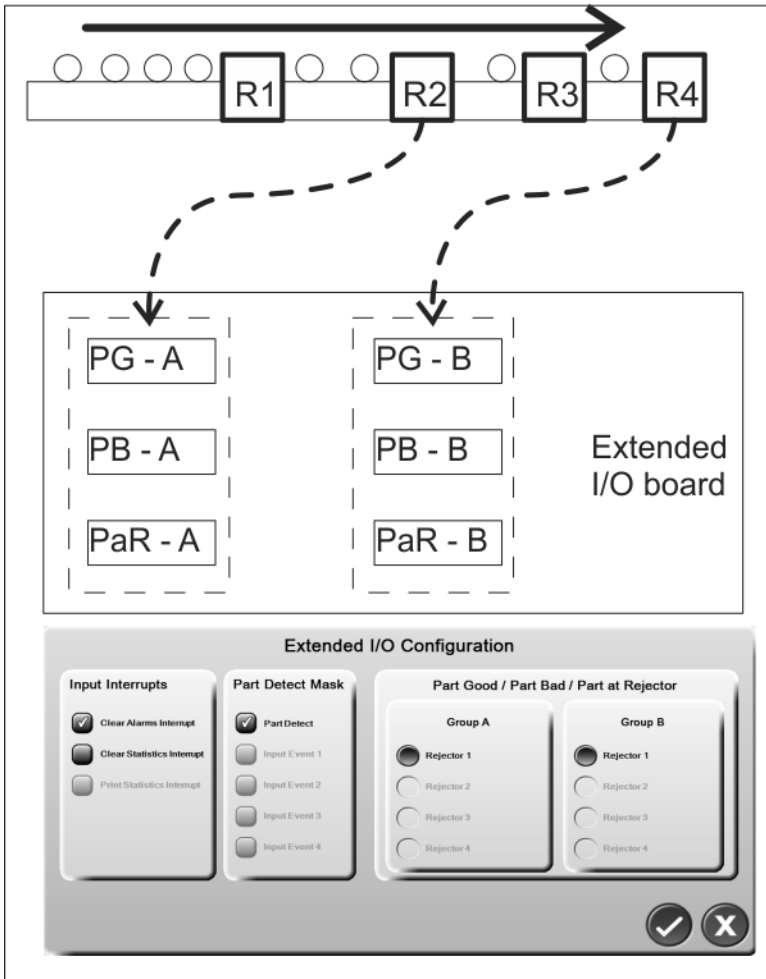

Example 2 below:

Group A is triggered when the part passes Rejector 2, and Group B is also triggered when the part passes Rejector 2.

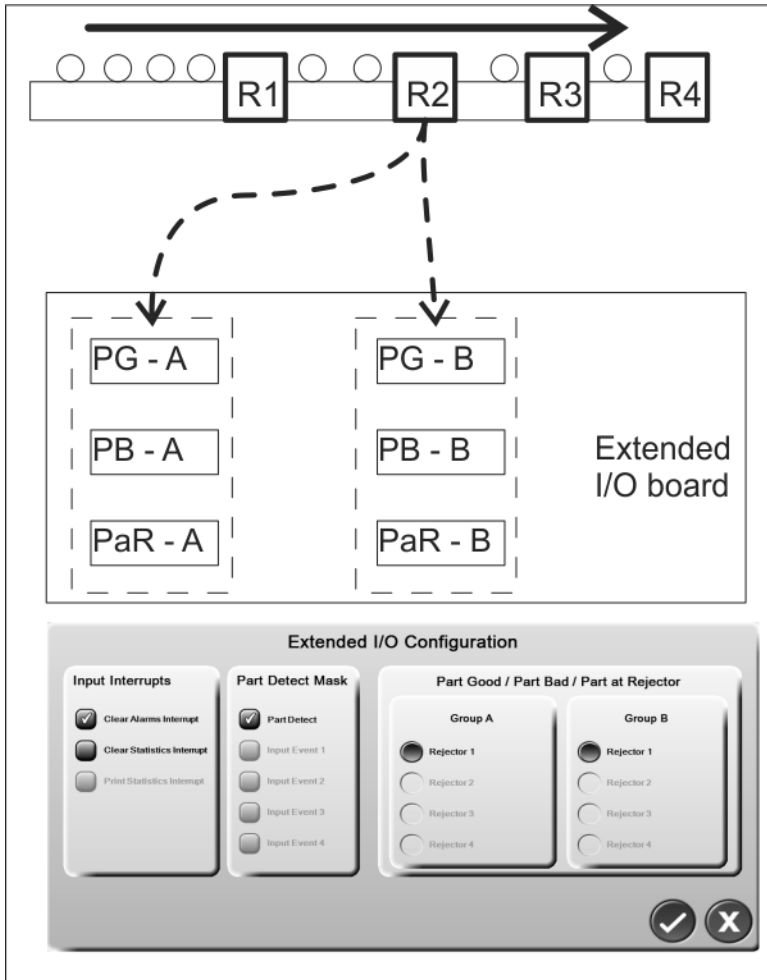

Chapter 9 Maintenance

When carrying out maintenance or repair work:



Disconnect master switch. For switch locations, refer to the Power Up and Power Down section.



Before starting the machine, ensure that no person is close to the machine.



If maintenance or repair requires the disconnection or removal of safety or protection systems, this operation must be supervised by authorized personnel who must ensure the prevention of personal injury or damage to the machine. All machine movements must be performed with limited speed and limited movements.



Maintenance or repair work on electrical components must be carried out exclusively by authorized, trained personnel. When running tests with power connected, you must strictly comply with the rules provided.



Personnel working on higher parts of a machine must wear a harness and hook it on to the structure and must always move with extreme caution.



Never perform lubrication or maintenance procedures on mechanical parts with the machine running.

LED Caution:



CAUTION - Possible hazardous optical radiation from LEDs. Do not stare at lamps.

Maintenance Frequency

Item	Description	Frequency
Observe proper rejection	Verify that defective parts are being rejected by inserting a known defective part through inspection	Daily
Observe Proper inspection	Verify that no stray parts are stuck in or near the inspection module or reject station	Daily
Observe Proper inspection	Verify that no buildup of dirt or contaminants has occurred on inspection module. Clean if necessary.	Daily
Observe Proper inspection	Verify that each camera's image is properly centered, focused, and properly lit. Adjust if necessary.	Daily
Glass surfaces	Clean with soft, clean, oil-free cloth dampened with glass cleaning solution	Daily
Plastic surfaces	Clean with soft, clean, oil-free cloth dampened with mild soap and water solution	Daily
Part Detect Sensor and Reflector	Clean with soft, clean, oil-free cloth dampened with mild soap and water solution. Wipe dry.	Weekly
Support Package	Create a snapshot of your Intellispec settings.	Monthly

Item	Description	Frequency
"Clean the Control Cabinet Filters" below	Rinse in clean water; use mild soap and water solution if oily.	Monthly
Acronis Backup	Create a full System Backup.	Yearly

Clean the Control Cabinet Filters

The filter should be cleaned once a month for best results. The filter is located on the side of the cabinet. Replace with a new filter when necessary.

Note: You may need to clean the filters weekly depending on plant conditions

What you need:

Recommended: "RP Super Filter Coat Adhesive." Find this on the Internet or in a hardware store near you.

To clean the filter:

1. Pull the ring on the bottom of the filter cover, and pull the filter down to remove it. (see photo below)
2. Remove the filter and clean it. DO NOT use caustic solutions.
 - If the filter contains dry dust and dirt, flush the filter with warm water from the exhaust side to the intake side
 - If the filter contains oily dust and dirt, clean it in soapy water, then rinse in clear water
3. Dry the filter completely [placing it with a corner down will assure complete drainage].
4. Recoat the filter with "RP Super Filter Coat Adhesive." Spray both sides for best results.
5. Place the filter back inside the filter cover.

